

# Important! Please Keep These Instructions For Future Reference

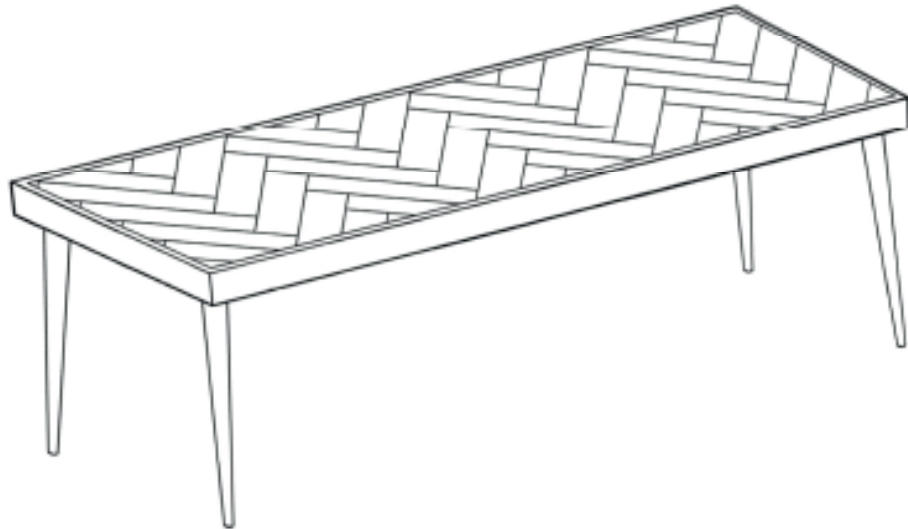

## Fittings and parts checklist

*When unpacking, please be careful not to discard any parts with the packaging. Before continuing, please make sure you have the following parts:*

1		X1
2		X4

### Fittings

A		x 8
B		x 8
C		x 1

# Important! Please Keep These Instructions For Future Reference

**BEFORE ASSEMBLY:** *place the contents on a carpeted or padded area to protect them from damage.*

## Step 1:

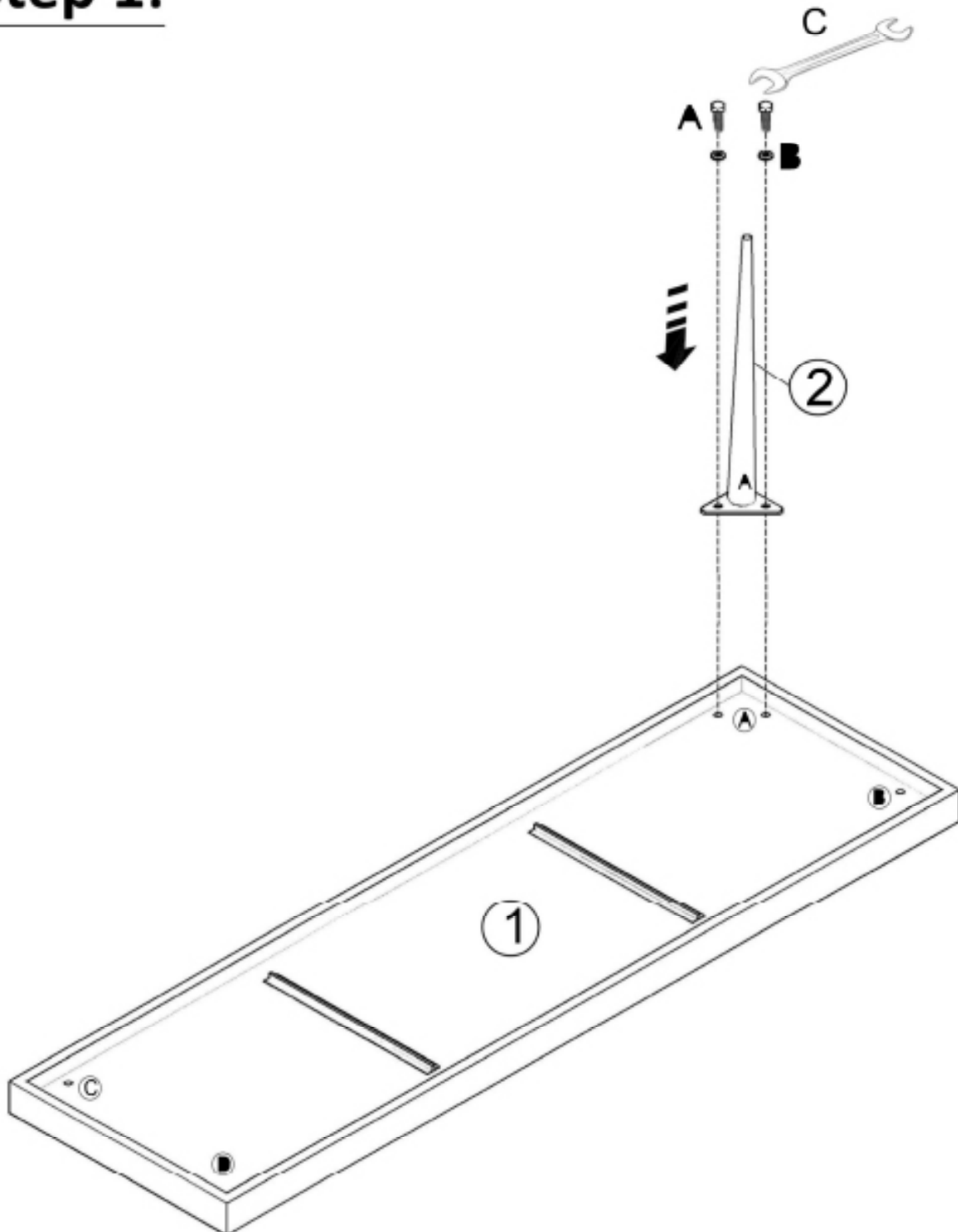

# Important! Please Keep These Instructions For Future Reference

## Step 2:

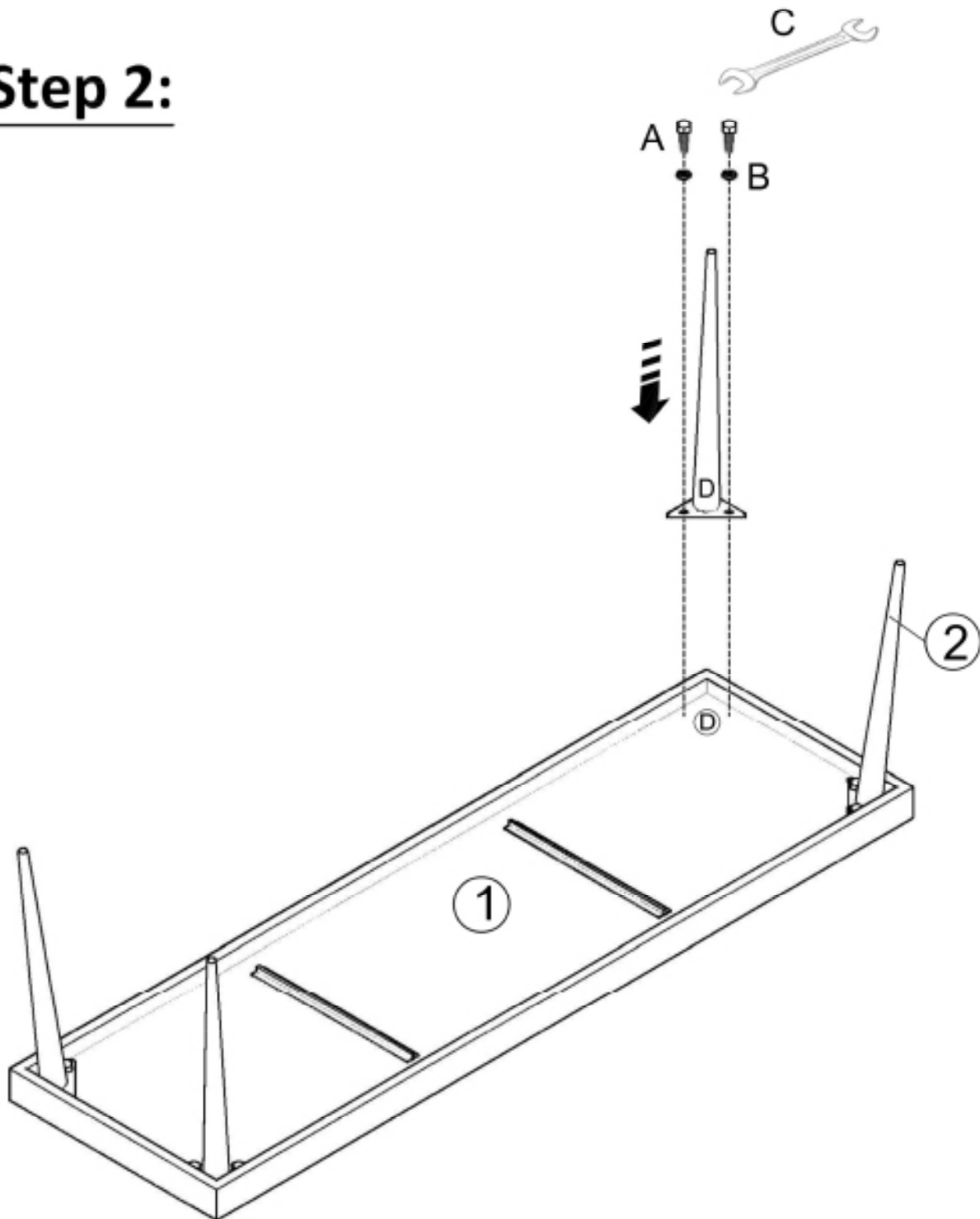

## Important! Please Keep These Instructions For Future Reference

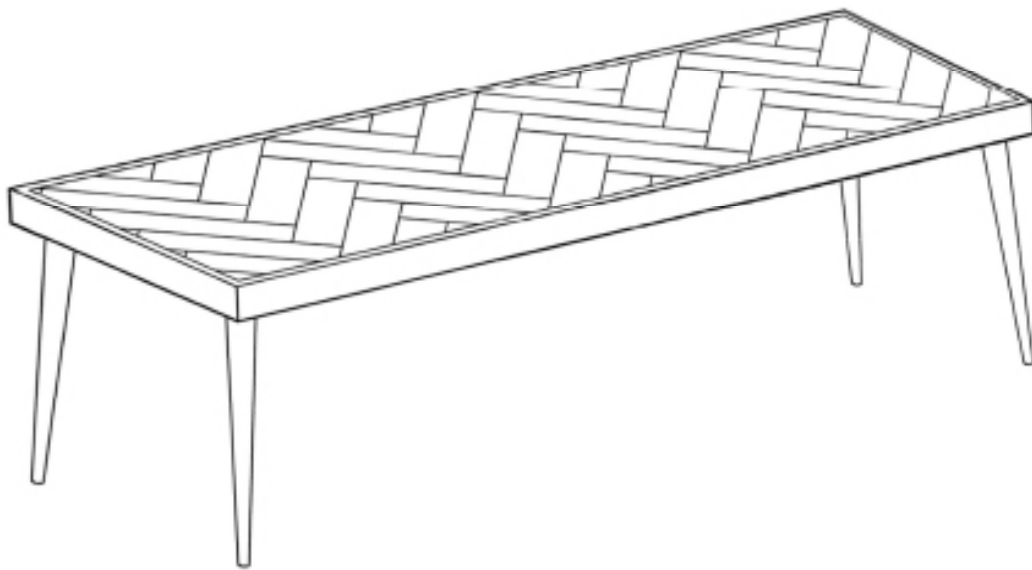

### **CLEANING & CARE:**

*For daily care, wipe with a soft dry cloth. Wipe spills with a clean dry cloth. Avoid the use of harsh cleaners and abrasives.*